

Whitaker, Jerry C. “Chapter 11 – Safe Handling of Vacuum Tube Devices”
Power Vacuum Tubes Handbook 2nd Edition.
Ed. Jerry C. Whitaker
Boca Raton: CRC Press LLC, 2000

Safe Handling of Vacuum Tube Devices

11.1 Introduction

Electrical safety is important when working with any type of electronic hardware. Because vacuum tubes operate at high voltages and currents, safety is doubly important. The primary areas of concern, from a safety standpoint, include:

- Electric shock
- Nonionizing radiation
- Beryllium oxide (BeO) ceramic dust
- Hot surfaces of vacuum tube devices
- Polychlorinated biphenyls (PCBs)

11.2 Electric Shock

Surprisingly little current is required to injure a person. Studies at Underwriters Laboratories (UL) show that the electrical resistance of the human body varies with the amount of moisture on the skin, the muscular structure of the body, and the applied voltage. The typical hand-to-hand resistance ranges between 500 Ω and 600 k Ω , depending on the conditions. Higher voltages have the capability to break down the outer layers of the skin, which can reduce the overall resistance value. UL uses the lower value, 500 Ω , as the standard resistance between major extremities, such as from the hand to the foot. This value is generally considered the minimum that would be encountered and, in fact, may not be unusual because wet conditions or a cut or other break in the skin significantly reduces human body resistance.

Table 11.1 The Effects of Current on the Human Body

Current	Effect
1 mA or less	No sensation, not felt
More than 3 mA	Painful shock
More than 10 mA	Local muscle contractions, sufficient to cause “freezing” to the circuit for 2.5 percent of the population
More than 15 mA	Local muscle contractions, sufficient to cause “freezing” to the circuit for 50 percent of the population
More than 30 mA	Breathing is difficult, can cause unconsciousness
50 mA to 100 mA	Possible ventricular fibrillation
100 mA to 200 mA	Certain ventricular fibrillation
More than 200 mA	Severe burns and muscular contractions; heart more apt to stop than to go into fibrillation
More than a few amperes	Irreparable damage to body tissue

11.2.1 Effects on the Human Body

Table 11.1 lists some effects that typically result when a person is connected across a current source with a hand-to-hand resistance of $2.4\text{ k}\Omega$. The table shows that a current of approximately 50 mA will flow between the hands, if one hand is in contact with a 120 V ac source and the other hand is grounded. The table indicates that even the relatively small current of 50 mA can produce *ventricular fibrillation* of the heart, and perhaps death. Medical literature describes ventricular fibrillation as rapid, uncoordinated contractions of the ventricles of the heart, resulting in loss of synchronization between heartbeat and pulse beat. The electrocardiograms shown in Figure 11.1 compare a healthy heart rhythm with one in ventricular fibrillation. Unfortunately, once ventricular fibrillation occurs, it will continue. Barring resuscitation techniques, death will ensue within a few minutes.

The route taken by the current through the body has a significant effect on the degree of injury. Even a small current, passing from one extremity through the heart to another extremity, is dangerous and capable of causing severe injury or electrocution. There are cases where a person has contacted extremely high current levels and lived to tell about it. However, usually when this happens, the current passes only through a single limb and not through the body. In these instances, the limb is often lost, but the person survives.

Current is not the only factor in electrocution. Figure 11.2 summarizes the relationship between current and time on the human body. The graph shows that 100 mA flowing through a human adult body for 2 s will cause death by electrocution. An important factor in electrocution, the *let-go range*, also is shown on the graph. This range is described as the amount of current that causes “freezing”, or the inability to let go of the conductor. At 10 mA, 2.5 percent of the population will be unable to let go of a “live” conductor. At 15 mA, 50 percent of the population will be unable to let go of an energized conductor. It is apparent from the graph that even a small amount of current can

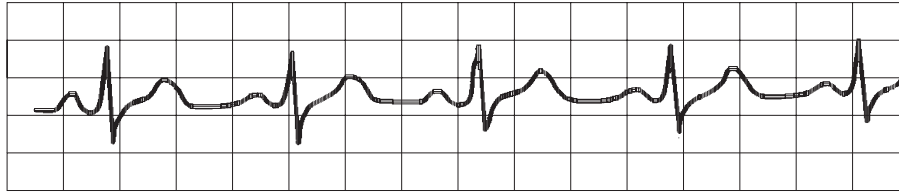

(a)

(b)

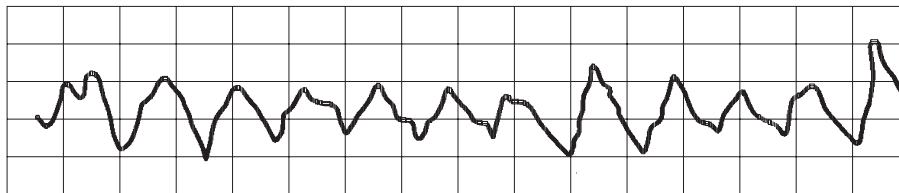

Figure 11.1 Electrocardiogram of a human heartbeat: (a) healthy rhythm, (b) ventricular fibrillation.

“freeze” someone to a conductor. The objective for those who must work around electric equipment is how to protect themselves from electric shock. [Table 11.2](#) lists required precautions for personnel working around high voltages.

11.2.2 Circuit Protection Hardware

The typical primary panel or equipment circuit breaker or fuse will not protect a person from electrocution. In the time it takes a fuse or circuit breaker to blow, someone could die. However, there are protection devices that, properly used, may help prevent electrocution. The *ground-fault current interrupter* (GFCI), shown in [Figure 11.3](#), works by monitoring the current being applied to the load. The GFI uses a differential transformer and looks for an imbalance in load current. If a current (5 mA, ± 1 mA) begins to flow between the neutral and ground or between the hot and ground leads, the differential transformer detects the leakage and opens up the primary circuit within 2.5 ms.

GFI's will not protect a person from every type of electrocution. If the victim becomes connected to both the neutral and the hot wire, the GFI will not detect an imbalance.

11.2.3 Working with High Voltage

Rubber gloves are commonly used by engineers working on high-voltage equipment. These gloves are designed to provide protection from hazardous voltages or RF when

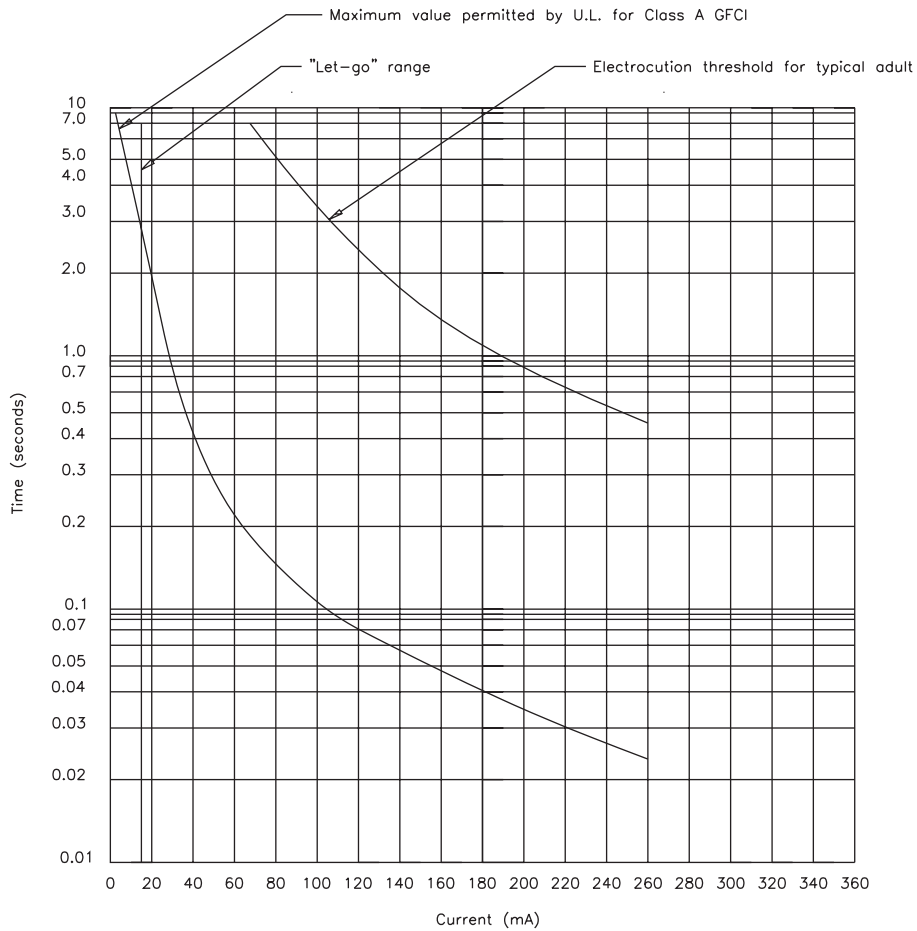

Figure 11.2 Effects of electric current and time on the human body. Note the “let-go” range.

the wearer is working on “hot” ac or RF circuits. Although the gloves may provide some protection from these hazards, placing too much reliance on them can have disastrous consequences. There are several reasons why gloves should be used with a great deal of caution and respect. A common mistake made by engineers is to assume that the gloves always provide complete protection. The gloves found in many facilities may be old or untested. Some may show signs of user repair, perhaps with electrical tape. Few tools could be more hazardous than such a pair of gloves.

Another mistake is not knowing the voltage rating of the gloves. Gloves are rated differently for both ac and dc voltages. For example, a *class 0* glove has a minimum dc breakdown voltage of 35 kV; the minimum ac breakdown voltage, however, is only 6 kV. Furthermore, high-voltage rubber gloves are not usually tested at RF frequencies,

Table 11.2 Required Safety Practices for Engineers Working Around High-Voltage Equipment

High-Voltage Precautions	
✓	Remove all ac power from the equipment. Do not rely on internal contactors or SCRs to remove dangerous ac.
✓	Trip the appropriate power distribution circuit breakers at the main breaker panel.
✓	Place signs as needed to indicate that the circuit is being serviced.
✓	Switch the equipment being serviced to the <i>local control</i> mode as provided.
✓	Discharge all capacitors using the discharge stick provided by the manufacturer.
✓	Do not remove, short circuit, or tamper with interlock switches on access covers, doors, enclosures, gates, panels, or shields.
✓	Keep away from live circuits.

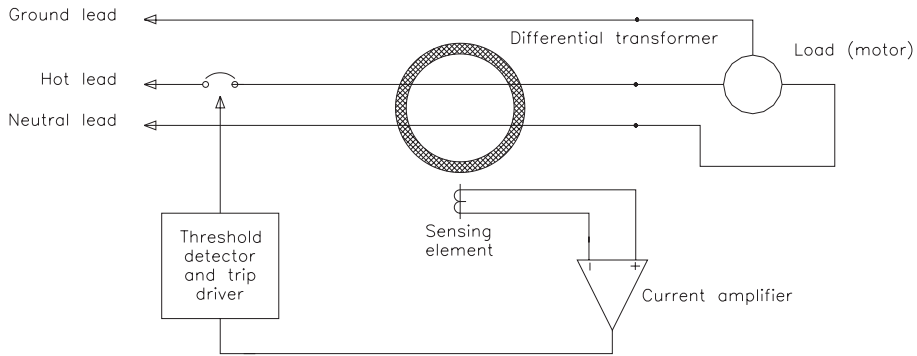

Figure 11.3 Basic design of a ground-fault interrupter (GFI).

and RF can burn a hole in the best of them. It is possible to develop dangerous working habits by assuming that gloves will offer the required protection.

Gloves alone may not be enough to protect an individual in certain situations. Recall the axiom of keeping one hand in a pocket while working around a device with current flowing? That advice is actually based on simple electricity. It is not the “hot” connection that causes the problem, but the ground connection that lets the current begin to flow. Studies have shown that more than 90 percent of electric equipment fatalities occurred when the grounded person contacted a live conductor. Line-to-line electrocution accounted for less than 10 percent of the deaths.

When working around high voltages, always look for grounded surfaces. Keep hands, feet, and other parts of the body away from any grounded surface. Even concrete

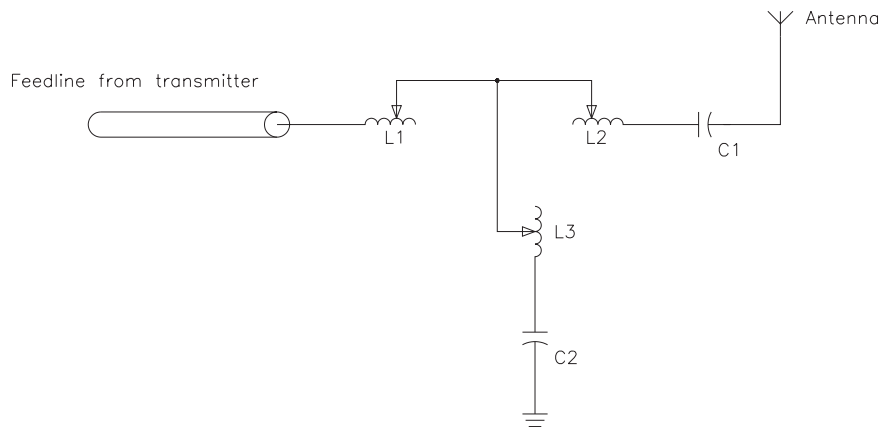

Figure 11.4 Example of how high voltages can be generated in an RF load matching unit.

can act as a ground if the voltage is sufficiently high. If work must be performed in “live” cabinets, then consider using, in addition to rubber gloves, a rubber floor mat, rubber vest, and rubber sleeves. Although this may seem to be a lot of trouble, consider the consequences of making a mistake. Of course, the best troubleshooting methodology is never to work on any circuit without being certain that no hazardous voltages are present. In addition, any circuits or contactors that normally contain hazardous voltages should be firmly grounded before work begins.

RF Considerations

Engineers often rely on electrical gloves when making adjustments to live RF circuits. This practice, however, can be extremely dangerous. Consider the typical load matching unit shown in Figure 11.4. In this configuration, disconnecting the coil from either L2 or L3 places the full RF output literally at the engineer’s fingertips. Depending on the impedances involved, the voltages can become quite high, even in a circuit that normally is relatively tame.

In the Figure 11.4 example, assume that the load impedance is approximately $106 + j202 \Omega$. With 1 kW feeding into the load, the rms voltage at the matching output will be approximately 700 V. The peak voltage (which determines insulating requirements) will be close to 1 kV, and perhaps more than twice that if the carrier is being amplitude-modulated. At the instant the output coil clip is disconnected, the current in the shunt leg will increase rapidly, and the voltage easily could more than double.

11.2.4 First Aid Procedures

All engineers working around high-voltage equipment should be familiar with first aid treatment for electric shock and burns. Always keep a first aid kit on hand at the facility. Figure 11.5 illustrates the basic treatment for victims of electric shock. Copy

If the victim is not responsive, follow the A-B-Cs of basic life support.

A AIRWAY: If the victim is unconscious, open airway.



1. Lift up neck
2. Push forehead back
3. Clear out mouth if necessary
4. Observe for breathing

B BREATHING: If the victim is not breathing, begin artificial breathing.



1. Tilt head
2. Pinch nostrils
3. Make airtight seal
4. Provide four quick full breaths

Check carotid pulse. If pulse is absent, begin artificial circulation. Remember that mouth-to-mouth resuscitation must be commenced as soon as possible.

C CIRCULATION: Depress the sternum 1.2 to 2 inches.

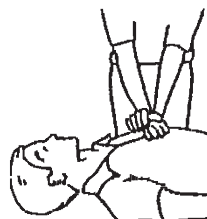
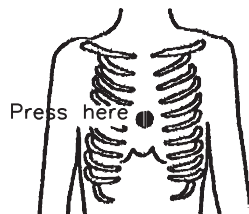

For situations in which there is one rescuer, provide 15 compressions and then 2 quick breaths. The approximate rate of compressions should be 80 per minute.

For situations in which there are two rescuers, provide 5 compressions and then 1 breath. The approximate rate of compressions should be 60 per minute.

Do not interrupt the rhythm of compressions when a second person is giving breaths.

If the victim is responsive, keep warm and quiet, loosen clothing, and place in a reclining position. Call for medical assistance as soon as possible.

Figure 11.5 Basic first aid treatment for electric shock.

the information, and post it in a prominent location. Better yet, obtain more detailed information from the local heart association or Red Cross chapter. Personalized instruction on first aid usually is available locally.

11.3 Operating Hazards

A number of potential hazards exist in the operation and maintenance of high-power vacuum tube RF equipment. Maintenance personnel must exercise extreme care around such hardware. Consider the following guidelines:

- Use caution around the high-voltage stages of the equipment. Many power tubes operate at voltages high enough to kill through electrocution. Always break the primary ac circuit of the power supply, and discharge all high-voltage capacitors.
- Minimize exposure to RF radiation. Do not permit personnel to be in the vicinity of open, energized RF generating circuits, RF transmission systems (waveguides, cables, or connectors), or energized antennas. High levels of radiation can result in severe bodily injury, including blindness. Cardiac pacemakers may also be affected.
- Avoid contact with beryllium oxide (BeO) ceramic dust and fumes. BeO ceramic material may be used as a thermal link to carry heat from a tube to the heat sink. Do not perform any operation on any BeO ceramic that might produce dust or fumes, such as grinding, grit blasting, or acid cleaning. Beryllium oxide dust and fumes are highly toxic, and breathing them can result in serious injury or death. BeO ceramics must be disposed of as prescribed by the device manufacturer.
- Avoid contact with hot surfaces within the equipment. The anode portion of most power tubes is air-cooled. The external surface normally operates at a high temperature (up to 250°C). Other portions of the tube also may reach high temperatures, especially the cathode insulator and the cathode/heater surfaces. All hot surfaces may remain hot for an extended time after the tube is shut off. To prevent serious burns, avoid bodily contact with these surfaces during tube operation and for a reasonable cool-down period afterward. [Table 11.3](#) lists basic first aid procedures for burns.

11.3.1 OSHA Safety Considerations

The U.S. government has taken a number of steps to help improve safety within the workplace under the auspices of the Occupational Safety and Health Administration (OSHA). The agency helps industries monitor and correct safety practices. OSHA has developed a number of guidelines designed to help prevent accidents. OSHA records show that electrical standards are among the most frequently violated of all safety standards. [Table 11.4](#) lists 16 of the most common electrical violations, including exposure of live conductors, improperly labeled equipment, and faulty grounding.

Table 11.3 Basic First Aid Procedures for Burns (More detailed information can be obtained from any Red Cross office.)

Extensively Burned and Broken Skin	
✓	Cover affected area with a clean sheet or cloth.
✓	Do not break blisters, remove tissue, remove adhered particles of clothing, or apply any salve or ointment.
✓	Treat victim for shock as required.
✓	Arrange for transportation to a hospital as quickly as possible.
✓	If arms or legs are affected, keep them elevated.
✓	If medical help will not be available within an hour and the victim is conscious and not vomiting, prepare a weak solution of salt and soda: 1 level teaspoon of salt and ½ level teaspoon of baking soda to each quart of tepid water. Allow the victim to sip slowly about 4 ounces (half a glass) over a period of 15 minutes. Discontinue fluid intake if vomiting occurs. (Do not offer alcohol.)
Less Severe Burns (First and Second Degree)	
✓	Apply cool (not ice-cold) compresses using the cleanest available cloth article.
✓	Do not break blisters, remove tissue, remove adhered particles of clothing, or apply salve or ointment.
✓	Apply clean, dry dressing if necessary.
✓	Treat victim for shock as required.
✓	Arrange for transportation to a hospital as quickly as possible.
✓	If arms or legs are affected, keep them elevated.

Protective Covers

Exposure of live conductors is a common safety violation. All potentially dangerous electric conductors should be covered with protective panels. The danger is that someone may come into contact with the exposed current-carrying conductors. It is also possible for metallic objects such as ladders, cable, or tools to contact a hazardous voltage, creating a life-threatening condition. Open panels also present a fire hazard.

Identification and Marking

Circuit breakers and switch panels should be properly identified and labeled. Labels on breakers and equipment switches may be many years old and may no longer reflect the equipment actually in use. This is a safety hazard. Casualties or unnecessary damage can be the result of an improperly labeled circuit panel if no one who understands the system is available in an emergency. If a number of devices are connected to a single disconnect switch or breaker, a diagram should be provided for clarification. Label with brief phrases, and use clear, permanent, and legible markings.

Equipment marking is a closely related area of concern. This is not the same thing as equipment identification. Marking equipment means labeling the equipment breaker

Table 11.4 Sixteen Common OSHA Violations (*After* [1].)

Fact Sheet	Subject	NEC ¹ Reference
1	Guarding of live parts	110-17
2	Identification	110-22
3	Uses allowed for flexible cord	400-7
4	Prohibited uses of flexible cord	400-8
5	Pull at joints and terminals must be prevented	400-10
6.1	Effective grounding, Part 1	250-51
6.2	Effective grounding, Part 2	250-51
7	Grounding of fixed equipment, general	250-42
8	Grounding of fixed equipment, specific	250-43
9	Grounding of equipment connected by cord and plug	250-45
10	Methods of grounding, cord and plug-connected equipment	250-59
11	AC circuits and systems to be grounded	250-5
12	Location of overcurrent devices	240-24
13	Splices in flexible cords	400-9
14	Electrical connections	110-14
15	Marking equipment	110-21
16	Working clearances about electric equipment	110-16
¹ National Electrical Code		

panels and ac disconnect switches according to device rating. Breaker boxes should contain a nameplate showing the manufacturer, rating, and other pertinent electrical factors. The intent is to prevent devices from being subjected to excessive loads or voltages.

Grounding

OSHA regulations describe two types of grounding: *system grounding* and *equipment grounding*. System grounding actually connects one of the current-carrying conductors (such as the terminals of a supply transformer) to ground. (See [Figure 11.6](#).) Equipment grounding connects all of the noncurrent-carrying metal surfaces together and to ground. From a grounding standpoint, the only difference between a grounded electrical system and an ungrounded electrical system is that the *main bonding jumper* from the service equipment ground to a current-carrying conductor is omitted in the ungrounded system. The system ground performs two tasks:

- It provides the final connection from equipment-grounding conductors to the grounded circuit conductor, thus completing the ground-fault loop.

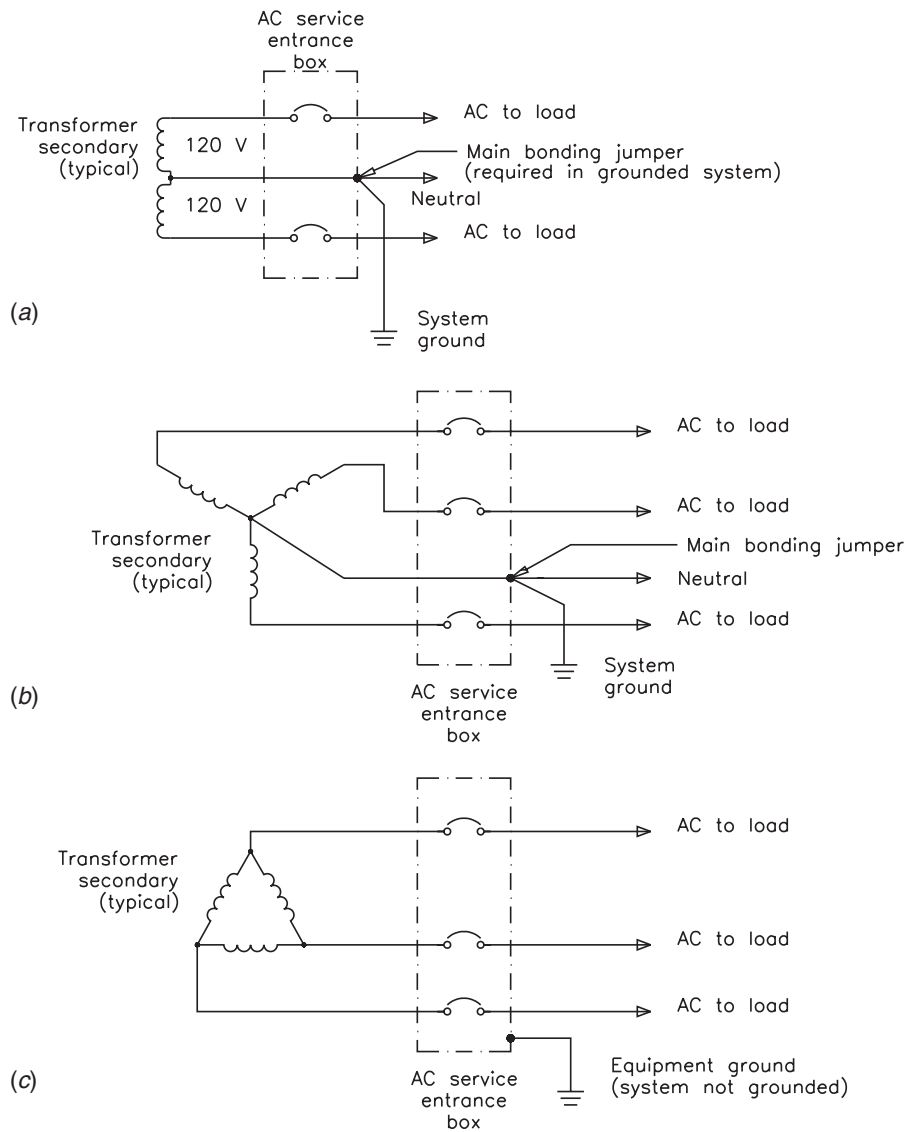

Figure 11.6 AC service entrance bonding requirements: (a) 120 V phase-to-neutral (240 V phase-to-phase), (b) 3-phase 208 V wye (120 V phase-to-neutral), (c) 3-phase 240 V (or 480 V) delta. Note that the main bonding jumper is required in only two of the designs.

- It solidly ties the electrical system and its enclosures to their surroundings (usually earth, structural steel, and plumbing). This prevents voltages at any source from rising to harmfully high voltage-to-ground levels.

Note that equipment grounding—bonding all electric equipment to ground—is required whether or not the system is grounded. Equipment grounding serves two important tasks:

- It bonds all surfaces together so that there can be no voltage difference among them.
- It provides a ground-fault current path from a fault location back to the electrical source, so that if a fault current develops, it will rise to a level high enough to operate the breaker or fuse.

The National Electrical Code (NEC) is complex and contains numerous requirements concerning electrical safety. The fact sheets listed in [Table 11.4](#) are available from OSHA.

11.3.2 Beryllium Oxide Ceramics

Some tubes, both power grid and microwave, contain beryllium oxide (BeO) ceramics, typically at the output waveguide window or around the cathode. Never perform any operations on BeO ceramics that produce dust or fumes, such as grinding, grit blasting, or acid cleaning. Beryllium oxide dust and fumes are highly toxic, and breathing them can result in serious personal injury or death.

If a broken window is suspected on a microwave tube, carefully remove the device from its waveguide, and seal the output flange of the tube with tape. Because BeO warning labels may be obliterated or missing, maintenance personnel should contact the tube manufacturer before performing any work on the device. Some tubes have BeO internal to the vacuum envelope.

Take precautions to protect personnel working in the disposal or salvage of tubes containing BeO. All such personnel should be made aware of the deadly hazards involved and the necessity for great care and attention to safety precautions. Some tube manufacturers will dispose of tubes without charge, provided they are returned to the manufacturer prepaid, with a written request for disposal.

11.3.3 Corrosive and Poisonous Compounds

The external output waveguides and cathode high-voltage bushings of microwave tubes are sometimes operated in systems that use a dielectric gas to impede microwave or high-voltage breakdown. If breakdown does occur, the gas may decompose and combine with impurities, such as air or water vapor, to form highly toxic and corrosive compounds. Examples include Freon gas, which may form lethal *phosgene*, and sulfur hexafluoride (SF₆) gas, which may form highly toxic and corrosive sulfur or fluorine compounds such as *beryllium fluoride*. When breakdown does occur in the presence of these gases, proceed as follows:

- Ventilate the area to outside air
- Avoid breathing any fumes or touching any liquids that develop

- Take precautions appropriate for beryllium compounds and for other highly toxic and corrosive substances

If a coolant other than pure water is used, follow the precautions supplied by the coolant manufacturer.

11.3.4 FC-75 Toxic Vapor

The decomposition products of FC-75 are highly toxic. Decomposition may occur as a result of any of the following:

- Exposure to temperatures above 200°C
- Exposure to liquid fluorine or alkali metals (lithium, potassium, or sodium)
- Exposure to ionizing radiation

Known thermal decomposition products include *perfluoroisobutylene* (PFIB; $[\text{CF}_3]_2\text{C}=\text{CF}_2$), which is highly toxic in small concentrations.

If FC-75 has been exposed to temperatures above 200°C through fire, electric heating, or prolonged electric arcs, or has been exposed to alkali metals or strong ionizing radiation, take the following steps:

- Strictly avoid breathing any fumes or vapors.
- Thoroughly ventilate the area.
- Strictly avoid any contact with the FC-75.

Under such conditions, promptly replace the FC-75 and handle and dispose of the contaminated FC-75 as a toxic waste.

11.3.5 Nonionizing Radiation

Nonionizing radio frequency radiation (RFR) resulting from high-intensity RF fields is a growing concern to engineers who must work around high-power transmission equipment. The principal medical concern regarding nonionizing radiation involves heating of various body tissues, which can have serious effects, particularly if there is no mechanism for heat removal. Recent research has also noted, in some cases, subtle psychological and physiological changes at radiation levels below the threshold for heat-induced biological effects. However, the consensus is that most effects are thermal in nature.

High levels of RFR can affect one or more body systems or organs. Areas identified as potentially sensitive include the ocular (eye) system, reproductive system, and the immune system. Nonionizing radiation also is thought to be responsible for metabolic effects on the central nervous system and cardiac system.

In spite of these studies, many of which are ongoing, there is still no clear evidence in Western literature that exposure to medium-level nonionizing radiation results in detrimental effects. Russian findings, on the other hand, suggest that occupational ex-

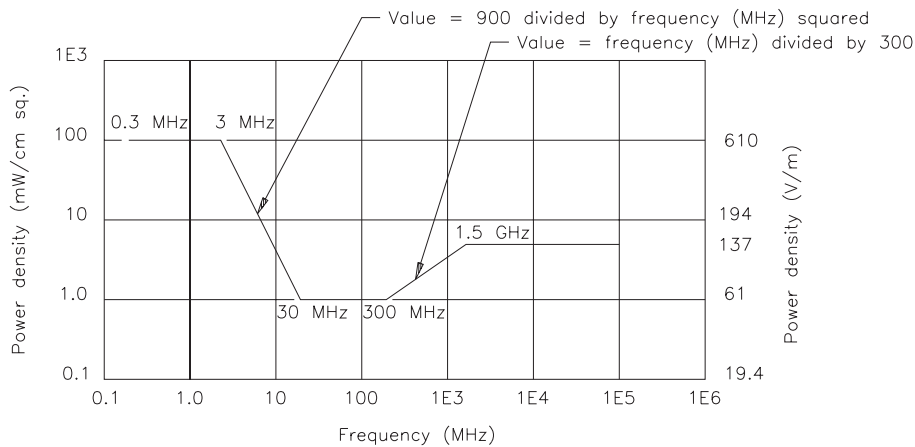

Figure 11.7 The power density limits for nonionizing radiation exposure for humans.

posure to RFR at power densities above 1.0 mW/cm² does result in symptoms, particularly in the central nervous system.

Clearly, the jury is still out as to the ultimate biological effects of RFR. Until the situation is better defined, however, the assumption must be made that potentially serious effects can result from excessive exposure. Compliance with existing standards should be the minimum goal, to protect members of the public as well as facility employees.

NEPA Mandate

The National Environmental Policy Act of 1969 required the Federal Communications Commission to place controls on nonionizing radiation. The purpose was to prevent possible harm to the public at large and to those who must work near sources of the radiation. Action was delayed because no hard and fast evidence existed that low- and medium-level RF energy is harmful to human life. Also, there was no evidence showing that radio waves from radio and TV stations did not constitute a health hazard.

During the delay, many studies were carried out in an attempt to identify those levels of radiation that might be harmful. From the research, suggested limits were developed by the American National Standards Institute (ANSI) and stated in the document known as ANSI C95.1-1982. The protection criteria outlined in the standard are shown in [Figure 11.7](#).

The energy-level criteria were developed by representatives from a number of industries and educational institutions after performing research on the possible effects of nonionizing radiation. The projects focused on absorption of RF energy by the human body, based upon simulated human body models. In preparing the document, ANSI attempted to determine those levels of incident radiation that would cause the

body to absorb less than 0.4 W/kg of mass (averaged over the whole body) or peak absorption values of 8 W/kg over any 1 gram of body tissue.

From the data, the researchers found that energy would be absorbed more readily at some frequencies than at others. The absorption rates were found to be functions of the size of a specific individual and the frequency of the signal being evaluated. It was the result of these absorption rates that culminated in the shape of the *safe curve* shown in the figure. ANSI concluded that no harm would come to individuals exposed to radio energy fields, as long as specific values were not exceeded when averaged over a period of 0.1 hour. It was also concluded that higher values for a brief period would not pose difficulties if the levels shown in the standard document were not exceeded when averaged over the 0.1-hour time period.

The FCC adopted ANSI C95.1-1982 as a standard that would ensure adequate protection to the public and to industry personnel who are involved in working around RF equipment and antenna structures.

Revised Guidelines

The ANSI C95.1-1982 standard was intended to be reviewed at 5-year intervals. Accordingly, the 1982 standard was due for reaffirmation or revision in 1987. The process was indeed begun by ANSI, but was handed off to the Institute of Electrical and Electronics Engineers (IEEE) for completion. In 1991, the revised document was completed and submitted to ANSI for acceptance as ANSI/IEEE C95.1-1992.

The IEEE standard incorporated changes from the 1982 ANSI document in four major areas:

- An additional safety factor was provided in certain situations. The most significant change was the introduction of new *uncontrolled* (public) exposure guidelines, generally established at one-fifth of the *controlled* (occupational) exposure guidelines. [Figure 11.8](#) illustrates the concept for the microwave frequency band.
- For the first time, guidelines were included for body currents; examination of the electric and magnetic fields were determined to be insufficient to determine compliance.
- Minor adjustments were made to occupational guidelines, including relaxation of the guidelines at certain frequencies and the introduction of *breakpoints* at new frequencies.
- Measurement procedures were changed in several aspects, most notably with respect to spatial averaging and to minimum separation from reradiating objects and structures at the site.

The revised guidelines are complex and beyond the scope of this handbook. Refer to the ANSI/IEEE document for details.

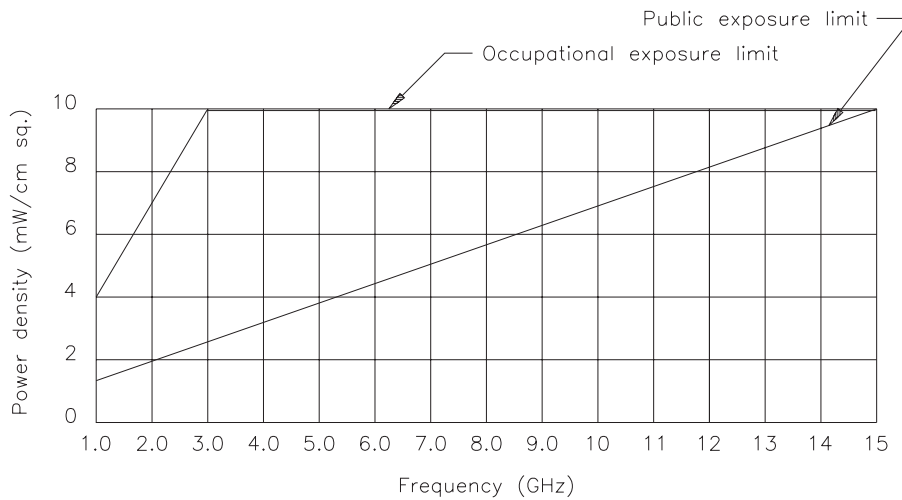

Figure 11.8 ANSI/IEEE exposure guidelines for microwave frequencies.

Multiple-User Sites

At a multiple-user site, the responsibility for assessing the RFR situation—although officially triggered by either a new user or the license renewal of all site tenants—is, in reality, the joint responsibility of all the site tenants. In a multiple-user environment involving various frequencies, and various protection criteria, compliance is indicated when the fraction of the RFR limit within each pertinent frequency band is established and added to the sum of all the other fractional contributions. The sum must not be greater than 1.0. Evaluating the multiple-user environment is not a simple matter, and corrective actions, if indicated, may be quite complex.

Operator Safety Considerations

RF energy must be contained properly by shielding and transmission lines. All input and output RF connections, cables, flanges, and gaskets must be RF leakproof. The following guidelines should be followed at all times:

- Never operate a power tube without a properly matched RF energy absorbing load attached.
- Never look into or expose any part of the body to an antenna or open RF generating tube, circuit, or RF transmission system that is energized.
- Monitor the RF system for radiation leakage at regular intervals and after servicing.

11.3.6 X-Ray Radiation Hazard

The voltages typically used in microwave tubes are capable of producing dangerous X rays. As voltages increase beyond 15 kV, metal-body tubes are capable of producing progressively more dangerous radiation. Adequate X-ray shielding must be provided on all sides of such tubes, particularly at the cathode and collector ends, as well as at the modulator and pulse transformer tanks (as appropriate). High-voltage tubes never should be operated without adequate X-ray shielding in place. The X-ray radiation of the device should be checked at regular intervals and after servicing.

11.3.7 Implosion Hazard

Because of the high internal vacuum in power grid and microwave tubes, the glass or ceramic output window or envelope can shatter inward (implode) if struck with sufficient force or exposed to sufficient mechanical shock. Flying debris could result in bodily injury, including cuts and puncture wounds. If the device is made of beryllium oxide ceramic, implosion may produce highly toxic dust or fumes.

In the event of such an implosion, assume that toxic BeO ceramic is involved unless confirmed otherwise.

11.3.8 Hot Coolant and Surfaces

Extreme heat occurs in the electron collector of a microwave tube and the anode of a power grid tube during operation. Coolant channels used for water or vapor cooling also can reach high temperatures (boiling—100°C—and above), and the coolant is typically under pressure (as high as 100 psi). Some devices are cooled by boiling the coolant to form steam.

Contact with hot portions of the tube or its cooling system can scald or burn. Carefully check that all fittings and connections are secure, and monitor back pressure for changes in cooling system performance. If back pressure is increased above normal operating values, shut the system down and clear the restriction.

For a device whose anode or collector is air-cooled, the external surface normally operates at a temperature of 200 to 300°C. Other parts of the tube also may reach high temperatures, particularly the cathode insulator and the cathode/heater surfaces. All hot surfaces remain hot for an extended time after the tube is shut off. To prevent serious burns, take care to avoid bodily contact with these surfaces during operation and for a reasonable cool-down period afterward.

11.3.9 Polychlorinated Biphenyls

PCBs belong to a family of organic compounds known as *chlorinated hydrocarbons*. Virtually all PCBs in existence today have been synthetically manufactured. PCBs have a heavy oil-like consistency, high boiling point, a high degree of chemical stability, low flammability, and low electrical conductivity. These characteristics resulted in the widespread use of PCBs in high-voltage capacitors and transformers. Commercial

Table 11.5 Commonly Used Names for PCB Insulating Material

PCB Trade Names					
Apiolio	Abestol	Askarel ¹	Aroclor B	Chlorexto	Chlophen
Chlorinol	Clorphon	Diaclor	DK	Dykanol	EEC-18
Elemex	Eucarel	Fenclor	Hyvol	Inclor	Inerteen
Kanechlor	No-Flamol	Phenodlor	Pydraul	Pyralene	Pyranol
Pyroclor	Sal-T-Kuhl	Santothern FR	Santovac	Solvol	Thermin

¹ Generic name used for nonflammable dielectric fluids containing PCBs.

products containing PCBs were widely distributed between 1957 and 1977 under several trade names including:

- Aroclor
- Pyroclor
- Sanotherm
- Pyranol
- Askarel

Askarel is also a generic name used for nonflammable dielectric fluids containing PCBs. Table 11.5 lists some common trade names used for Askarel. These trade names typically will be listed on the nameplate of a PCB transformer or capacitor.

PCBs are harmful because once they are released into the environment, they tend not to break apart into other substances. Instead, PCBs persist, taking several decades to slowly decompose. By remaining in the environment, they can be taken up and stored in the fatty tissues of all organisms, from which they are slowly released into the bloodstream. Therefore, because of the storage in fat, the concentration of PCBs in body tissues can increase with time, even though PCB exposure levels may be quite low. This process is called *bioaccumulation*. Furthermore, as PCBs accumulate in the tissues of simple organisms, and as they are consumed by progressively higher organisms, the concentration increases. This process is called *biomagnification*. These two factors are especially significant because PCBs are harmful even at low levels. Specifically, PCBs have been shown to cause chronic (long-term) toxic effects in some species of animals and aquatic life. Well-documented tests on laboratory animals show that various levels of PCBs can cause reproductive effects, gastric disorders, skin lesions, and cancerous tumors.

PCBs may enter the body through the lungs, the gastrointestinal tract, and the skin. After absorption, PCBs are circulated in the blood throughout the body and stored in

fatty tissues and a variety of organs, including the liver, kidneys, lungs, adrenal glands, brain, heart, and skin.

The health risk from PCBs lies not only in the PCB itself, but also in the chemicals that develop when PCBs are heated. Laboratory studies have confirmed that PCB by-products, including *polychlorinated dibenzofurans* (PCDFs) and *polychlorinated dibenzo-p-dioxins* (PCDDs), are formed when PCBs or *chlorobenzenes* are heated to temperatures ranging from approximately 900 to 1300°F. Unfortunately, these products are more toxic than PCBs themselves.

Governmental Action

The U.S. Congress took action to control PCBs in October 1975 by passing the Toxic Substances Control Act (TSCA). A section of this law specifically directed the EPA to regulate PCBs. Three years later the Environmental Protection Agency (EPA) issued regulations to implement the congressional ban on the manufacture, processing, distribution, and disposal of PCBs. Since that time, several revisions and updates have been issued by the EPA. One of these revisions, issued in 1982, specifically addressed the type of equipment used in industrial plants and transmitting stations. Failure to properly follow the rules regarding the use and disposal of PCBs has resulted in high fines and even jail sentences.

Although PCBs are no longer being produced for electrical products in the United States, there are thousands of PCB transformers and millions of small PCB capacitors still in use or in storage. The threat of widespread contamination from PCB fire-related incidents is one reason behind the EPA's efforts to reduce the number of PCB products in the environment. The users of high-power equipment are affected by the regulations primarily because of the widespread use of PCB transformers and capacitors. These components usually are located in older (pre-1979) systems, so this is the first place to look for them. However, some facilities also maintain their own primary power transformers. Unless these transformers are of recent vintage, it is quite likely that they too contain a PCB dielectric. [Table 11.6](#) lists the primary classifications of PCB devices.

PCB Components

The two most common PCB components are transformers and capacitors. A PCB transformer is one containing at least 500 ppm (parts per million) PCBs in the dielectric fluid. An Askarel transformer generally has 600,000 ppm or more. A PCB transformer may be converted to a *PCB-contaminated device* (50 to 500 ppm) or a *non-PCB device* (less than 50 ppm) by having it drained, refilled, and tested. The testing must not take place until the transformer has been in service for a minimum of 90 days. Note that this is *not* something a maintenance technician can do. It is the exclusive domain of specialized remanufacturing companies.

PCB transformers must be inspected quarterly for leaks. If an impervious dike is built around the transformer sufficient to contain all of the liquid material, the inspections can be conducted yearly. Similarly, if the transformer is tested and found to con-

Table 11.6 Definition of PCB Terms as Identified by the EPA

Term	Definition	Examples
PCB	Any chemical substance that is limited to the biphenyl molecule that has been chlorinated to varying degrees, or any combination of substances that contain such substances.	PCB dielectric fluids, PCB heat-transfer fluids, PCB hydraulic fluids, 2,2',4-trichlorobiphenyl
PCB article	Any manufactured article, other than a PCB container, that contains PCBs and whose surface has been in direct contact with PCBs.	Capacitors, transformers, electric motors, pumps, pipes
PCB container	A device used to contain PCBs or PCB articles, and whose surface has been in direct contact with PCBs.	Packages, cans, bottles, bags, barrels, drums, tanks
PCB article container	A device used to contain PCB articles or equipment, and whose surface has not been in direct contact with PCBs.	Packages, cans, bottles, bags, barrels, drums, tanks
PCB equipment	Any manufactured item, other than a PCB container or PCB article container, that contains a PCB article or other PCB equipment.	Microwave systems, fluorescent light ballasts, electronic equipment
PCB item	Any PCB article, PCB article container, PCB container, or PCB equipment that deliberately or unintentionally contains, or has as a part of it, any PCBs.	
PCB transformer	Any transformer that contains PCBs in concentrations of 500 ppm or greater.	
PCB contaminated	Any electric equipment that contains more than 50, but less than 500 ppm of PCBs. (Oil-filled electric equipment other than circuit breakers, reclosers, and cable whose PCB concentration is unknown must be assumed to be PCB-contaminated electric equipment.)	Transformers, capacitors, contaminated circuit breakers, reclosers, voltage regulators, switches, cable, electromagnets

tain less than 60,000 ppm, a yearly inspection is sufficient. Failed PCB transformers cannot be repaired; they must be properly disposed of.

If a leak develops, it must be contained and daily inspections begun. A cleanup must be initiated as soon as possible, but no later than 48 hours after the leak is discovered. Adequate records must be kept of all inspections, leaks, and actions taken for 3 years after disposal of the component. Combustible materials must be kept a minimum of 5 m from a PCB transformer and its enclosure.

As of October 1, 1990, the use of PCB transformers (500 ppm or greater) was prohibited in or near commercial buildings when the secondary voltages are 480 V ac or higher.

The EPA regulations also require that the operator notify others of the possible dangers. All PCB transformers (including PCB transformers in storage for reuse) must be registered with the local fire department. The following information must be supplied:

- The location of the PCB transformer(s).
- Address(es) of the building(s) and, for outdoor PCB transformers, the location.
- Principal constituent of the dielectric fluid in the transformer(s).
- Name and telephone number of the contact person in the event of a fire involving the equipment.

Any PCB transformers used in a commercial building must be registered with the building owner. All building owners within 30 m of such PCB transformers also must be notified. In the event of a fire-related incident involving the release of PCBs, the Coast Guard National Spill Response Center (800-424-8802) must be notified immediately. Appropriate measures also must be taken to contain and control any possible PCB release into water.

Capacitors are divided into two size classes, *large* and *small*. A PCB small capacitor contains less than 1.36 kg (3 lbs) of dielectric fluid. A capacitor having less than 100 in³ also is considered to contain less than 3 lb of dielectric fluid. A PCB large capacitor has a volume of more than 200 in³ and is considered to contain more than 3 lb of dielectric fluid. Any capacitor having a volume between 100 and 200 in³ is considered to contain 3 lb of dielectric, provided the total weight is less than 9 lb. A PCB *large high-voltage capacitor* contains 3 lb or more of dielectric fluid and operates at voltages of 2 kV or greater. A *large low-voltage capacitor* also contains 3 lb or more of dielectric fluid but operates below 2 kV.

The use and servicing of PCB small capacitors is not restricted by the EPA unless there is a leak. In that event, the leak must be repaired or the capacitor disposed of. Disposal may be handled by an approved incineration facility, or the component may be placed in a specified container and buried in an approved chemical waste landfill. Items such as capacitors that are leaking oil greater than 500 ppm PCBs should be taken to an EPA-approved PCB disposal facility.

PCB Liability Management

Properly managing the PCB risk is not particularly difficult; the keys are understanding the regulations and following them carefully. Any program should include the following steps:

- Locate and identify all PCB devices. Check all stored or spare devices.
- Properly label PCB transformers and capacitors according to EPA requirements.
- Perform the required inspections and maintain an accurate log of PCB items, their location, inspection results, and actions taken. These records must be maintained for 3 years after disposal of the PCB component.
- Complete the annual report of PCBs and PCB items by July 1 of each year. This report must be retained for 5 years.
- Arrange for necessary disposal through a company licensed to handle PCBs. If there are any doubts about the company's license, contact the EPA.
- Report the location of all PCB transformers to the local fire department and to the owners of any nearby buildings.

The importance of following the EPA regulations cannot be overstated.

11.4 References

1. National Electrical Code, NFPA #70.

11.5 Bibliography

- “Current Intelligence Bulletin #45,” National Institute for Occupational Safety and Health, Division of Standards Development and Technology Transfer, February 24, 1986.
- Code of Federal Regulations, 40, Part 761.
- “Electrical Standards Reference Manual,” U.S. Department of Labor, Washington, DC.
- Hammett, William F., “Meeting IEEE C95.1-1991 Requirements,” *NAB 1993 Broadcast Engineering Conference Proceedings*, National Association of Broadcasters, Washington, D.C., pp. 471 - 476, April 1993.
- Hammar, Willie, *Occupational Safety Management and Engineering*, Prentice Hall, New York.
- Markley, Donald, “Complying with RF Emission Standards,” *Broadcast Engineering*, Intertec Publishing, Overland Park, KS, May 1986.
- “Occupational Injuries and Illnesses in the United States by Industry,” OSHA Bulletin 2278, U.S. Department of Labor, Washington, DC, 1985.
- OSHA, “Electrical Hazard Fact Sheets,” U.S. Department of Labor, Washington, DC, January 1987.
- OSHA, “Handbook for Small Business,” U.S. Department of Labor, Washington, DC.

- Pfrimmer, Jack, "Identifying and Managing PCBs in Broadcast Facilities," *1987 NAB Engineering Conference Proceedings*, National Association of Broadcasters, Washington, DC, 1987.
- "Safety Precautions," Publication no. 3386A, Varian Associates, Palo Alto, CA, March 1985.
- Smith, Milford K., Jr., "RF Radiation Compliance," *Proceedings of the Broadcast Engineering Conference*, Society of Broadcast Engineers, Indianapolis, IN, 1989.
- "Toxics Information Series," Office of Toxic Substances, July 1983.
- Whitaker, Jerry C., *AC Power Systems*, 2nd Ed., CRC Press, Boca Raton, FL, 1998.
- Whitaker, Jerry C., G. DeSantis, and C. Paulson, *Interconnecting Electronic Systems*, CRC Press, Boca Raton, FL, 1993.
- Whitaker, Jerry C., *Maintaining Electronic Systems*, CRC Press, Boca Raton, FL, 1991.
- Whitaker, Jerry C., *Radio Frequency Transmission Systems: Design and Operation*, McGraw-Hill, New York, 1990.